

Illuminating Asia

2014-2015 CATALOG

INGROUND DOT SLIM R MONO

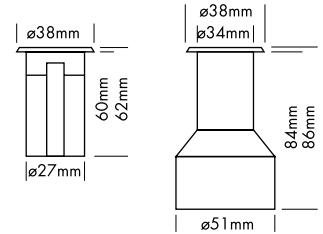
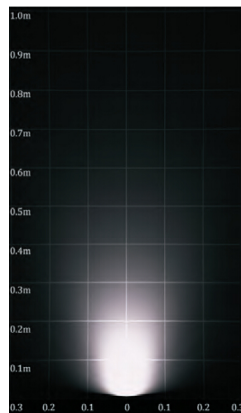

IASPL INGROUND DOT SLIM R is a decorative point of light and suitable for integration in floors, ceilings, walls or stairs indoors and outdoors.

- dimmable or DMX 512, DALI, 1-10 V controllable by IASPL RGB MULTI power supplies/controller
- incl. PVC plastic mounting sleeve



Technical Data

| | |
|------------------------------|--|
| IP classification: | IP67 (for outdoor use) |
| Power source: | 24 VDC |
| Ring: | stainless steel 316 |
| Housing: | powder coated aluminium grey 5 mm tempered glass |
| Mounting sleeve: | PVC plastic |
| Load capacity: | exert force area of $\varnothing 10 \text{ mm} = 100 \text{ kg}$, |
| Electrical connection: | 1x cable 0,5 m H05RN-F 2x 1,0 mm ² to open wires |
| Operating temperature range: | -10° C till +45° C |

Photometric Data

| | | | |
|---------------------|-------------------------|-------------|-------------|
| LED type: | OSRAM 2 Watt high power | | |
| Luminous flux: | white | 30 | Lumen per m |
| | warm white | 25 | Lumen per m |
| Colour temperature: | white | 5500-6500 K | |
| | warm white | 2700-3500 K | |
| CRI: | white | 70+ | |
| | warm white | 80+ | |
| Beam angle: | 120° | | |

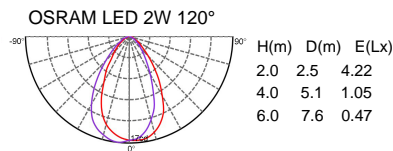

Product Type

IES is available

| order code | colour | LED pcs | LED power | Power consumption* | weight |
|------------|------------|---------|-----------|--------------------|--------|
| BZYA0260S | white | 1 | 2 Watt | 2-2.5 Watt | 0.2 kg |
| BZYA0230S | warm white | 1 | 2 Watt | 2-2.5 Watt | 0.2 kg |

Actual power consumption

INGROUND DOT SLIM S MONO

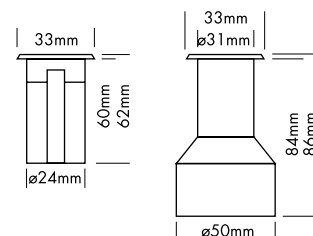
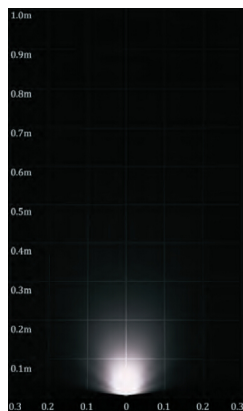

IASPL INGROUND DOT SLIM S is a decorative point of light and suitable for integration in floors, ceilings, walls or stairs indoors and outdoors.

- dimmable or DMX 512, DALI, 1-10 V controllable by IASPL RGB MULTI power supplies/controller
- incl. PVC plastic mounting sleeve

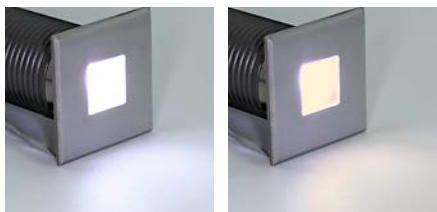

Technical Data

| | |
|------------------------------|--|
| IP classification: | IP67 (for outdoor use) |
| Power source: | 24 VDC |
| Ring: | stainless steel 316 |
| Housing: | powder coated aluminium grey 5 mm tempered glass |
| Mounting sleeve: | PVC plastic |
| Load capacity: | exert force area of $\varnothing 10 \text{ mm} = 100 \text{ kg}$ |
| Electrical connection: | 1x cable 0,5 m H05RN-F 2x 1,0 mm ² to open wires |
| Operating temperature range: | -10° C till +45° C |

Photometric Data

| | | | |
|---------------------|---------------------------|-------------|-------------|
| LED type: | OSRAM 0.5 Watt high power | | |
| Luminous flux: | white | 6 | Lumen per m |
| | warm white | 5 | Lumen per m |
| Colour temperature: | white | 5500-6500 K | |
| | warm white | 2700-3500 K | |
| CRI: | white | 70+ | |
| | warm white | 80+ | |
| Beam angle: | 120° | | |

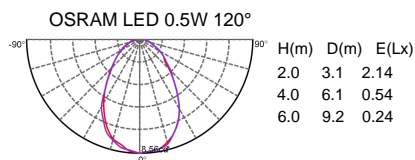

Product Type

IES is available

| order code | colour | LED pcs | LED power | Power consumption * | weight |
|------------|------------|---------|-----------|---------------------|--------|
| BZYXA0260B | white | 1 | 0.5 Watt | 0.5-1 Watt | 0.1 kg |
| BZYXA0230B | warm white | 1 | 0.5 Watt | 0.5-1 Watt | 0.1 kg |

Actual power consumption

INGROUND 1R MONO

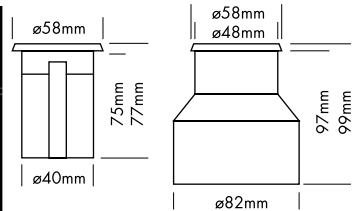
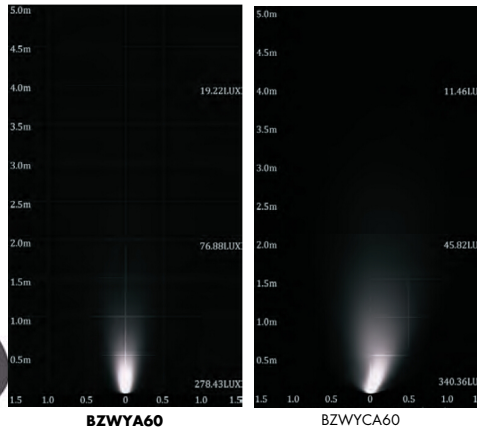

IASPL INGROUND 1R series is designed for floor or ceiling integration and offers various design possibilities in architectural illumination.

- dimmable or DMX 512, DALI, 1-10 V controllable by IASPL RGB MULTI power supplies/controller
- incl. PVC plastic mounting sleeve

Technical Data

| | |
|------------------------------|---|
| IP classification: | IP67 (for outdoor use) |
| Power source: | 24 VDC |
| Ring: | stainless steel 316 |
| Housing: | powder coated aluminium grey 7 mm tempered glass |
| Mounting sleeve: | PVC plastic |
| Load capacity: | exert force area of ø10 mm = 1300 kg |
| Electrical connection: | 1x cable 2 m H05RN-F 4x 0,75 mm ² to open wires |
| Operating temperature range: | -10° C till +45° C |

Photometric Data

| | | | |
|---------------------|---|-------------|-------------|
| LED type: | OSRAM 2 Watt high power | | |
| Luminous flux: | white | 70 | Lumen per m |
| | warm white | 65 | Lumen per m |
| Colour temperature: | white | 5500-6500 K | |
| | warm white | 2700-3500 K | |
| CRI: | white | 70+ | |
| | warm white | 70+ | |
| Beam angle: | 15° (only white), 30° and asymmetrical 35°/00 | | |

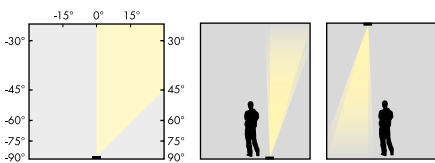

Asymmetrische Linse 45°/00 / Asymmetrical lens 45°/00

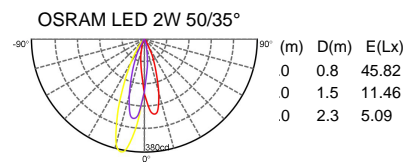
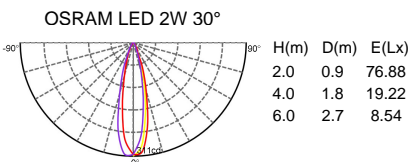

Product Type

IES is available

| order code | colour | beam angle | LED pcs | LED power | Power consumption* | weight |
|------------|------------|------------|---------|-----------|--------------------|--------|
| BZWYA60 | white | 30° | 1 | 2 Watt | 2,5-3 Watt | 0,3 kg |
| BZWYA30 | warm white | 30° | 1 | 2 Watt | 2,5-3 Watt | 0,3 kg |
| BZWYCA60 | white | 50/35 | 1 | 2 Watt | 2,5-3 Watt | 0,3 kg |
| BZWYCA30 | warm white | 50/35 | 1 | 2 Watt | 2,5-3 Watt | 0,3 kg |

Actual power consumption

INGROUND 1S MONO

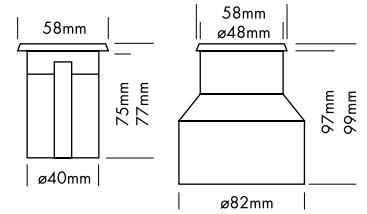

IASPL INGROUND 1S series is designed for floor or ceiling integration and offers various design possibilities in architectural illumination.

- dimmable or DMX 512, DALI, 1-10 V controllable by IASPL RGB MULTI power supplies/controller
- incl. PVC plastic mounting sleeve



Technical Data

| | |
|------------------------------|--|
| IP classification: | IP67 (for outdoor use) |
| Power source: | 24 VDC |
| Ring: | stainless steel 316 |
| Housing: | powder coated aluminium grey 7 mm tempered glass |
| Mounting sleeve: | PVC plastic |
| Load capacity: | exert force area of $\varnothing 10$ mm = 1300 kg |
| Electrical connection: | 1x cable 2 m H05RN-F 2x 1,0 mm ² to open wires |
| Operating temperature range: | -10° C till +45° C |

Photometric Data

| | | |
|---------------------|---|----------------------------|
| LED type: | OSRAM 2 Watt high power | |
| Luminous flux: | white 70 warm white 65 | Lumen per m Lumen per m |
| Colour temperature: | white 5500-6500 K warm white 2700-3500 K | |
| CRI: | white 70+ warm white 70+ | |
| Beam angle: | 15° (only white), 30° and asymmetrical 35°/00 | |

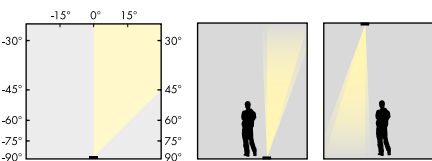

Asymmetrische Linse 45°/00 / Asymmetrical lens 45°/00



OSRAM LED 2W 30°

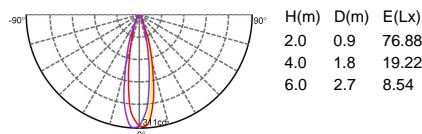

Product Type

IES is available

| order code | colour | beam angle | LED pcs | LED power | Power consumption* | weight |
|------------|------------|------------|---------|-----------|--------------------|--------|
| BZWXA60 | white | 30° | 1 | 2 Watt | 30-34 Watt | 0,3 kg |
| BZWXA30 | warm white | 30° | 1 | 2 Watt | 30-34 Watt | 0,3 kg |

Actual power consumption

INGROUND 1R TRILED RGB

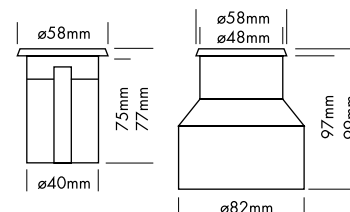
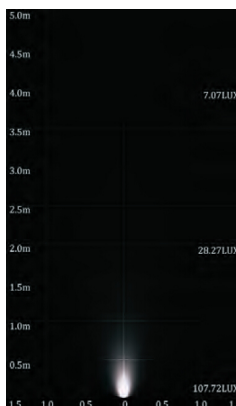

IASPL INGROUND 1R TRILED RGB series is designed for floor or ceiling integration and offers various design possibilities in architectural illumination.

- dimmable, autom. colour change, DMX 512, DALI, 1-10 V controllable by IASPL RGB MULTI power supplies/controller
- incl. PVC plastic mounting sleeve



| Technical Data | | Technical Data |
|------------------------|---|----------------|
| IP classification: | IP67 (for outdoor use) | |
| Power source: | 24 VDC Common Cathode (CC) | |
| Ring: | stainless steel 316 | |
| Housing: | powder coated aluminium grey 7 mm tempered glass | |
| Mounting sleeve: | PVC plastic | |
| Load capacity: | exert force area of ø10 mm = 1300 kg | |
| Electrical connection: | 1x cable 2 m H05RN-F 4x 0,75 mm ² to open wires | |

Operating temperature range: -10° C till +45° C

| Photometric Data | |
|------------------|---|
| LED type: | HARVATEK RGB 3-in-1 LEDs |
| Luminous flux: | red 15 Lumen green 25 Lumen blue 10 Lumen r+g+b (white) 45 Lumen |
| Wave length: | red 621 nm green 523 nm blue 471 nm |
| Beam angle: | 30° |

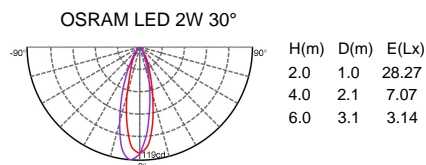

Product Type

IES is available

| order code | colour | LED pcs | LED power | Power consumption* | weight |
|------------|--------|---------|-----------|--------------------|--------|
| BZWYAR | RGB | 1 | 2 Watt | 3-3,5 Watt | 0,3 kg |

Actual power consumption

INGROUND DOT R MONO

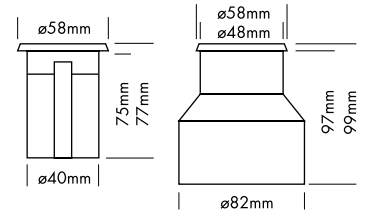
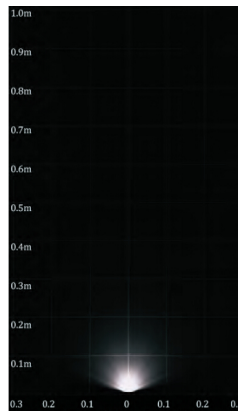

IASPL INGROUND DOT R MONO is a decorative point of light and suitable for integration in floors, ceilings, walls or stairs indoors and outdoors.

- dimmable or DMX 512, DALI, 1-10 V controllable by IASPL RGB MULTI power supplies/controller
- incl. PVC plastic mounting sleeve



Technical Data

| | |
|------------------------------|---|
| IP classification: | IP67 (for outdoor use) |
| Power source: | 24 VDC |
| Ring: | stainless steel 316 |
| Housing: | powder coated aluminium grey 7 mm tempered glass |
| Mounting sleeve: | PVC plastic |
| Load capacity: | exert force area of $\varnothing 10 \text{ mm} = 1300 \text{ kg}$ |
| Electrical connection: | 1 x cable 0,5 m H05RN-F 2x 1,0 mm ² to open wires |
| Operating temperature range: | -10° C till +45° C |



Photometric Data

| | | |
|---------------------|------------------------------------|-------------|
| LED type: | OSRAM SMD LEDs ULTRA BRIGHT 3-in-1 | |
| Luminous flux: | white | 2,5 Lumen |
| | amber | 0,3 Lumen |
| | blue | 0,4 Lumen |
| Colour temperature: | white | 5500-6500 K |
| Wave length: | amber | 590 nm |
| | blue | 469 nm |
| CRI: | white | 70+ |
| Beam angle: | 120° | |

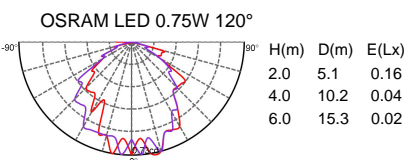

Product Type

IES is available

| order code | colour | LED pcs | LED power | Power consumption* | weight |
|------------|------------|---------|-----------|--------------------|--------|
| BZWYC60r | white | 3 | 0.75 Watt | 1 - 1.5 Watt | 0.3 kg |
| BZWYC30r | warm white | 3 | 0.75 Watt | 1 - 1.5 Watt | 0.3 kg |

Actual power consumption

INGROUND DOT S MONO

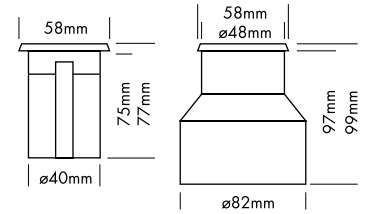

IASPL INGROUND DOT S MONO is a decorative point of light and suitable for integration in floors, ceilings, walls or stairs indoors and outdoors.

- dimmable or DMX 512, DALI, 1-10 V controllable by IASPL RGB MULTI power supplies/controller
- incl. PVC plastic mounting sleeve



Technical Data

| | |
|------------------------------|---|
| IP classification: | IP67 (for outdoor use) |
| Power source: | 24 VDC |
| Ring: | stainless steel 316 |
| Housing: | powder coated aluminium grey 7 mm tempered glass |
| Mounting sleeve: | PVC plastic |
| Load capacity: | exert force area of $\varnothing 10 \text{ mm} = 1300 \text{ kg}$ |
| Electrical connection: | 1x cable 0,5 m H05RN-F 2x 1,0 mm ² to open wires |
| Operating temperature range: | -10° C till +45° C |

Photometric Data

| | | |
|---------------------|------------------------------------|-------------|
| LED type: | OSRAM SMD LEDs ULTRA BRIGHT 3-in-1 | |
| Luminous flux: | white | 2,5 Lumen |
| | amber | 0,3 Lumen |
| | blue | 0,4 Lumen |
| Colour temperature: | white | 5500-6500 K |
| Wave length: | amber | 590 nm |
| | blue | 469 nm |
| CRI: | white | 70+ |
| Beam angle: | 120° | |

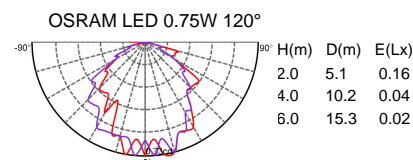

Product Type

IES is available

| order code | colour | LED pcs | LED power | Power consumption* | weight |
|------------|------------|---------|-----------|--------------------|--------|
| BZWSC60r | white | 3 | 0.75 Watt | 1-1.5 Watt | 0.3 kg |
| BZWSC30r | warm white | 3 | 0.75 Watt | 1-1.5 Watt | 0.3 kg |

Actual power consumption

INGROUND DOT R RGB

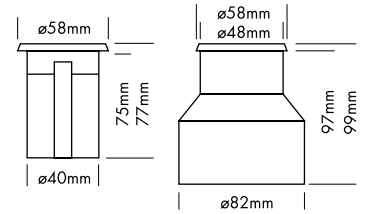

IASPL INGROUND DOT R RGB is a decorative point of light and suitable for integration in floors, ceilings, walls or stairs indoors and outdoors.

- dimmable, autom. colour change, DMX 512, DALI, 1-10 V controllable by ZSLED RGB MULTI power supplies/controller
- incl. PVC plastic mounting sleeve

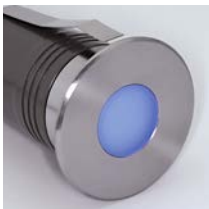

Technical Data

| | |
|------------------------------|---|
| IP classification: | IP67 (for outdoor use) |
| Power source: | 24 VDC Common Cathode (CC) |
| Ring: | stainless steel 316 |
| Housing: | powder coated aluminium grey 7 mm tempered glass |
| Mounting sleeve: | PVC plastic |
| Load capacity: | exert force area of $\varnothing 10 \text{ mm} = 1300 \text{ kg}$ |
| Electrical connection: | 1 x cable 0,5 m H05RN-F 4x 0,75 mm ² to open wires |
| Operating temperature range: | -10° C till +45° C |

Photometric Data

| | | |
|----------------|-----------------------|-----------|
| LED type: | OSRAM RGB 3-in-1 LEDs | |
| Luminous flux: | red | 0,2 Lumen |
| | green | 0,4 Lumen |
| | blue | 0,1 Lumen |
| | r+g+b (white) | 0,7 Lumen |
| Wave length: | red | 624 nm |
| | green | 526 nm |
| | blue | 470 nm |
| Beam angle: | 120° | |

OSRAM LED 0.75W 120°

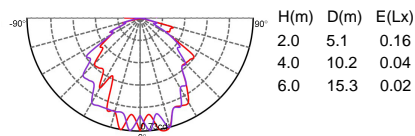

Product Type

IES is available

| order code | colour | LED pcs | LED power | Power consumption* | weight |
|------------|--------|---------|-----------|--------------------|--------|
| BZWYCRr | RGB | 3 | 0.75 Watt | 1-1.5 Watt | 0.3 kg |

Actual power consumption

INGROUND DOT S RGB

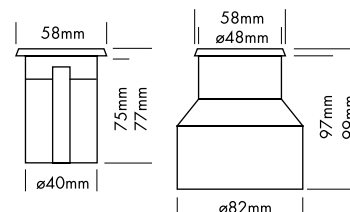

IASPL INGROUND DOT S RGB is a decorative point of light and suitable for integration in floors, ceilings, walls or stairs indoors and outdoors.

- dimmable, autom. colour change, DMX 512, DALI, 1-10 V controllable by IASPL RGB MULTI power supplies/controller
- incl. PVC plastic mounting sleeve



Technical Data

| | |
|------------------------------|---|
| IP classification: | IP67 (for outdoor use) |
| Power source: | 24 VDC Common Cathode (CC) |
| Ring: | stainless steel 316 |
| Housing: | powder coated aluminium grey 7 mm tempered glass |
| Mounting sleeve: | PVC plastic |
| Load capacity: | exert force area of $\varnothing 10 \text{ mm} = 1300 \text{ kg}$ |
| Electrical connection: | 1x cable 0,5 m H05RN-F 4x 0,75 mm ² to open wires |
| Operating temperature range: | -10° C till +45° C |

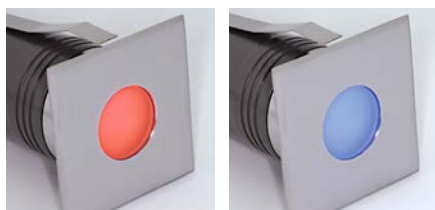

Photometric Data

| | | |
|----------------|-----------------------|-----------|
| LED type: | OSRAM RGB 3-in-1 LEDs | |
| Luminous flux: | red | 0,2 Lumen |
| | green | 0,4 Lumen |
| | blue | 0,1 Lumen |
| | r+g+b (white) | 0,7 Lumen |
| Wave length: | red | 624 nm |
| | green | 526 nm |
| | blue | 470 nm |
| Beam angle: | 120° | |

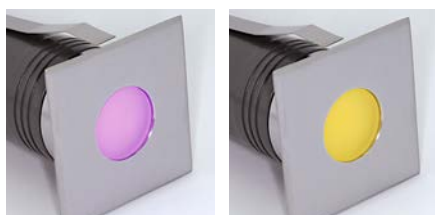

OSRAM LED 0.75W 120°

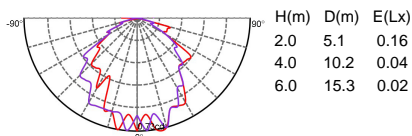

Product Type

IES is available

| order code | colour | LED pcs | LED power | Power consumption* | weight |
|------------|--------|---------|-----------|--------------------|--------|
| BZWXRr | RGB | 3 | 0.75 Watt | 1 - 1.5 Watt | 0.3 kg |

Actual power consumption

MUSEE LED WALKWAY INDICATOR - M1

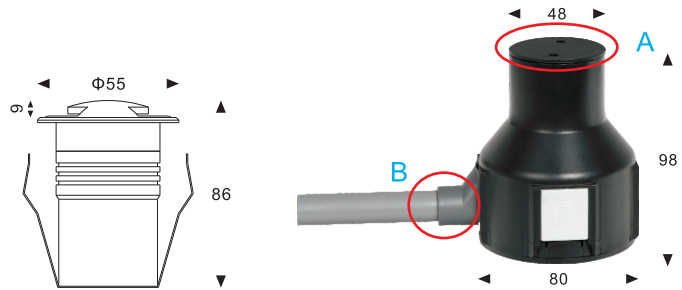
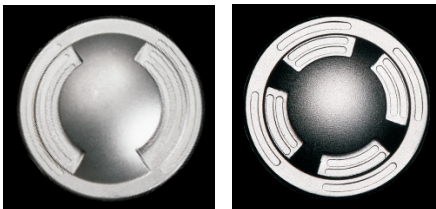

Technical Data

| | |
|------------------------------|---|
| IP classification: | IP67 |
| Power source: | 24 VDC/120VAC/240 VAC 50/60 Hz |
| Housing: | black, silver |
| Driver: | constant current output |
| Electrical connection: | HO5RN-F 2x1.0mm ² L=0.5m(low voltage) HO5RN-F 3x1.0mm ² L=0.5m(high voltage) |
| Operating temperature range: | -20° C till +40° C |
| Mounting sleeve: | O11 ABS plastic |

Photometric Data

| | | | |
|---------------------|---------------|-------------|--|
| LED: | OSRAM LED(2w) | | |
| Colour temperature: | neutral white | 4000-4500 K | |
| | warm white | 2700-3200 K | |
| | cool white | 6000-6500 K | |
| CRI: | neutral white | 80+ | |
| | warm white | 80+ | |

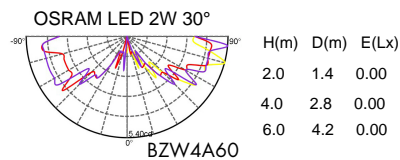
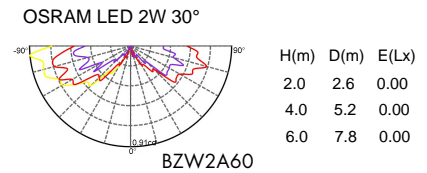
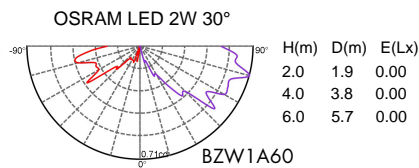

Product Type

IES is available

| order code | colour | LED pcs | LED power | Power consumption* | weight |
|------------|------------|---------|-----------|--------------------|---------|
| BZW1A60 | white | 1 | 2Watt | 2-3Watt | 0.98 kg |
| BZW1A30 | warm white | 1 | 2Watt | 2-3Watt | 0.98 kg |
| BZW2A60 | white | 1 | 2Watt | 2-3Watt | 0.98 kg |
| BZW2A30 | warm white | 1 | 2Watt | 2-3Watt | 0.98 kg |
| BZW4A60 | white | 1 | 2Watt | 2-3Watt | 0.98 kg |
| BZW4A30 | warm white | 1 | 2Watt | 2-3Watt | 0.98 kg |

Actual power consumption

MUSEE LED WALKWAY INDICATOR - M2

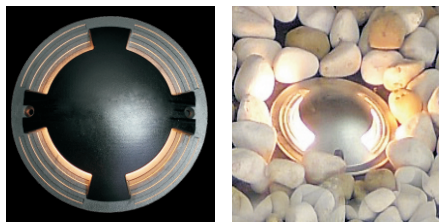
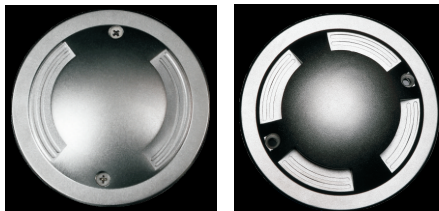
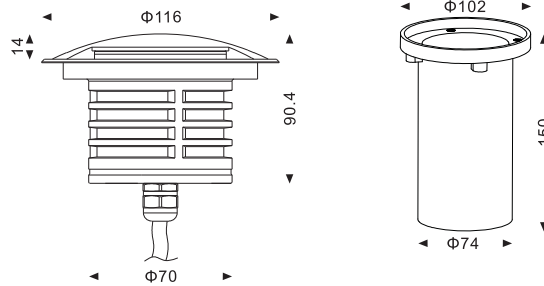

Technical Data

| | |
|------------------------------|---|
| IP classification: | IP67 |
| Power source: | 24 VDC/120VAC/240 VAC 50/60 Hz |
| Housing: | black,silver |
| Driver: | constant current output |
| Electrical connection: | HO5RN-F 2x1.0mm ² L=0.5m(low voltage) HO5RN-F 3x1.0mm ² L=0.5m(high voltage) |
| Operating temperature range: | -20° C till +40° C |
| Mounting sleeve: | 015PVC |

Photometric Data

| | | | |
|---------------------|-------------------|-------------|--|
| LED: | OSRAM LED(SMD 3W) | | |
| Colour temperature: | neutral white | 4000-4500 K | |
| | warm white | 2700-3500 K | |
| | cool white | 6000-6500 K | |
| CRI: | neutral white | 80+ | |
| | warm white | 80+ | |
| | cool white | 80+ | |

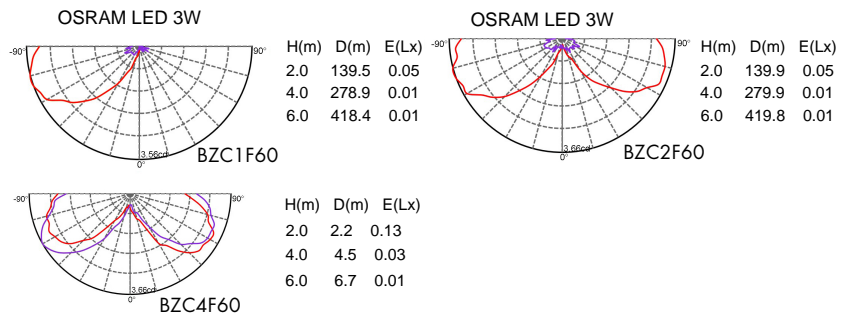

Product Type

IES is available

| order code | colour | LED pcs | LED power | Power consumption* | weight |
|------------|------------|---------|-----------|--------------------|---------|
| BZC1F60 | white | 6 | 3 Watt | 3-4 Watt | 0.98 kg |
| BZC1F30 | warm white | 6 | 3 Watt | 3-4 Watt | 0.98 kg |
| BZC2F60 | white | 6 | 3 Watt | 3-4 Watt | 0.98 kg |
| BZC2F30 | warm white | 6 | 3 Watt | 3-4 Watt | 0.98 kg |
| BZC4F60 | white | 6 | 3 Watt | 3-4 Watt | 0.98 kg |
| BZC4F30 | warm white | 6 | 3 Watt | 3-4 Watt | 0.98 kg |

Actual power consumption

MUSEE LED WALKWAY INDICATOR - M3

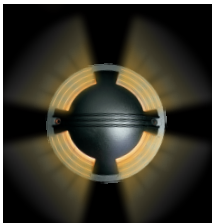
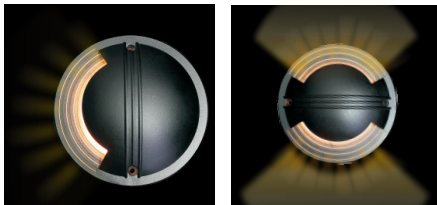
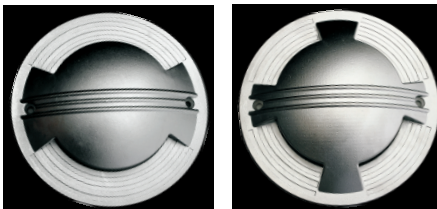
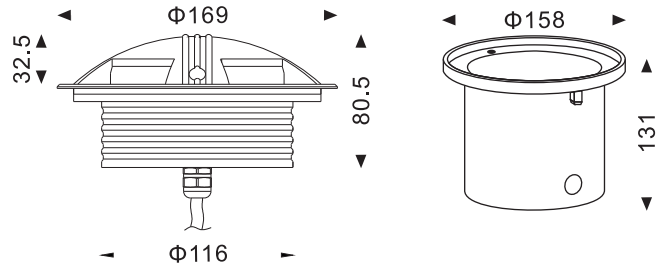
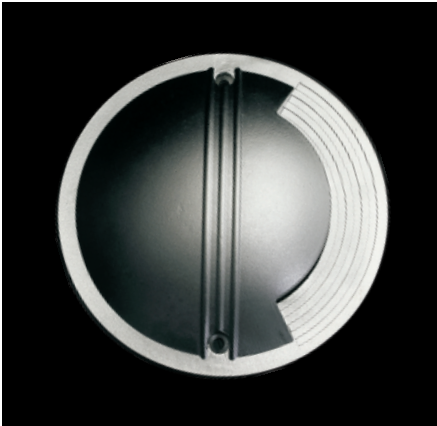

Technical Data

| | |
|------------------------------|---|
| IP classification: | IP67 |
| Power source: | 24 VDC/120VAC/240 VAC 50/60 Hz |
| Housing: | black, silver |
| Driver: | constant current output |
| Electrical connection: | HO5RN-F 2x1.0mm ² L=0.5m (low voltage) HO5RN-F 3x1.0mm ² L=0.5m (high voltage) |
| Operating temperature range: | -20° C till +40° C |
| Mounting sleeve: | Die-cast grey powder coater |

Photometric Data

| | | | |
|---------------------|------------------------------|-------------|--|
| LED: | OSRAM LED (0.6w 0.12w 0.24w) | | |
| Colour temperature: | neutral white | 4000-4500 K | |
| | warm white | 2700-3200 K | |
| | cool white | 6000-6500 K | |
| CRI: | neutral white | 80+ | |
| | warm white | 80+ | |

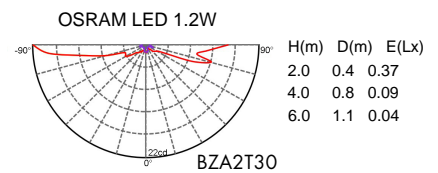
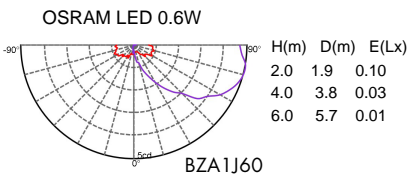

Product Type

IES is available

| order code | colour | LED pcs | LED power | Power consumption* | weight |
|------------|------------|---------|-----------|--------------------|---------|
| BZA1J60 | white | 10 | 0.6 | 0.6-0.7Watt | 0.98 kg |
| BZA1J30 | warm white | 10 | 0.6 | 0.6-0.7Watt | 0.98 kg |
| BZA2T60 | white | 20 | 1.2 | 1.2-1.4Watt | 0.98 kg |
| BZA2T30 | warm white | 20 | 1.2 | 1.2-1.4Watt | 0.98 kg |
| BZA4X60 | white | 24 | 1.44 | 1.5-1.6Watt | 0.98 kg |
| BZA4X30 | warm white | 24 | 1.44 | 1.5-1.6Watt | 0.98 kg |

Actual power consumption

INGROUND DOT LARGE R RGB

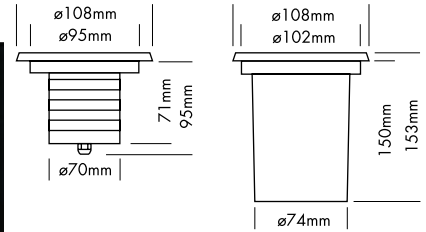
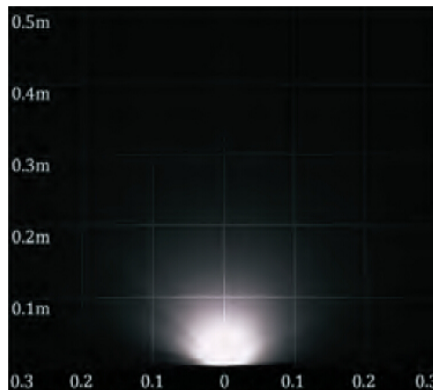

IASPL INGROUND DOT LARGE R is a decorative point of light and suitable for integration in floors, ceilings, walls or stairs indoors and outdoors.

- dimmable, autom. colour change, DMX 512, DALI, 1-10 V controllable by IASPL RGB MULTI power supplies/controller
- incl. PVC plastic mounting sleeve



Technical Data

| | |
|------------------------------|---|
| IP classification: | IP67 (for outdoor use) |
| Power source: | 24 VDC Common Cathode (CC) |
| Ring: | stainless steel 316 |
| Housing: | powder coated aluminium grey 8 mm tempered glass |
| Mounting sleeve: | PVC plastic |
| Load capacity: | exert force area of $\varnothing 10$ mm = 600 kg $\varnothing 30$ mm = 1800 kg |
| Electrical connection: | 1x cable 0,5 m H05RN-F 4x 0,75 mm ² to open wires |
| Operating temperature range: | -10° C till +45° C |

Photometric Data

| | | | |
|----------------|---------------------------|-----|-------|
| LED type: | OSRAM SMD RGB 3-in-1 LEDs | | |
| Luminous flux: | red | 1,5 | Lumen |
| | green | 2,5 | Lumen |
| | blue | 1,0 | Lumen |
| | r+g+b (white) | 4,5 | Lumen |
| Wave length: | red | 619 | nm |
| | green | 527 | nm |
| | blue | 471 | nm |
| Beam angle: | 120° | | |

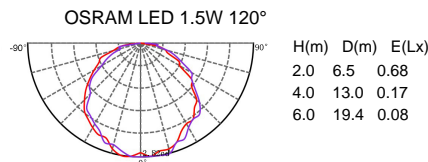

Product Type

IES is available

| order code | colour | LED pcs | LED power | Power consumption* | weight |
|------------|--------|---------|-----------|--------------------|--------|
| BZCYFRr | RGB | 6 | 1.5 Watt | 1 - 1.5 Watt | 0.9 kg |

Actual power consumption

INGROUND DOT LARGE S RGB

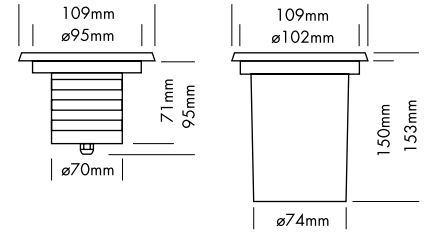
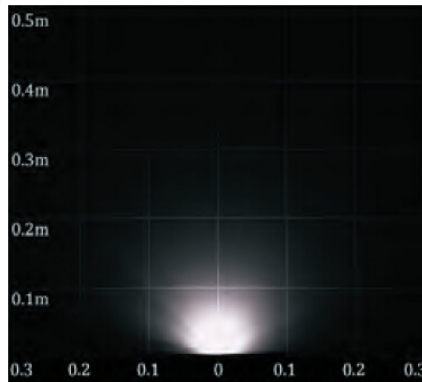

IASPL INGROUND DOT LARGE S is a decorative point of light and suitable for integration in floors, ceilings, walls or stairs indoors and outdoors.

- dimmable, autom. colour change, DMX 512, DALI, 1-10 V controllable by IASPL RGB MULTI power supplies/controller
- incl. PVC plastic mounting sleeve



Technical Data

| | |
|------------------------------|---|
| IP classification: | IP67 (for outdoor use) |
| Power source: | 24 VDC Common Cathode (CC) |
| Ring: | stainless steel 316 |
| Housing: | powder coated aluminium grey 8 mm tempered glass |
| Mounting sleeve: | PVC plastic |
| Load capacity: | exert force area of $\varnothing 10$ mm = 600 kg $\varnothing 30$ mm = 1800 kg |
| Electrical connection: | 1x cable 0,5 m H05RN-F 4x 0,75 mm ² to open wires |
| Operating temperature range: | -10° C till +45° C |

Photometric Data

| | | |
|----------------|---------------------------|-----------|
| LED type: | OSRAM SMD RGB 3-in-1 LEDs | |
| Luminous flux: | red | 1,5 Lumen |
| | green | 2,5 Lumen |
| | blue | 1,0 Lumen |
| | r+g+b (white) | 4,5 Lumen |
| Wave length: | red | 619 nm |
| | green | 527 nm |
| | blue | 471 nm |
| Beam angle: | 120° | |

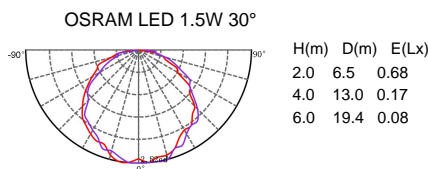

Product Type

IES is available

| order code | colour | LED pcs | LED power | Power consumption* | weight |
|------------|--------|---------|-----------|--------------------|--------|
| BZCXFR | RGB | 6 | 1.5 Watt | 1-1.5 Watt | 0.9 kg |

Actual power consumption

INGROUND DOT LARGE R MONO

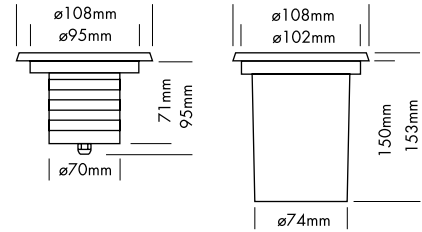
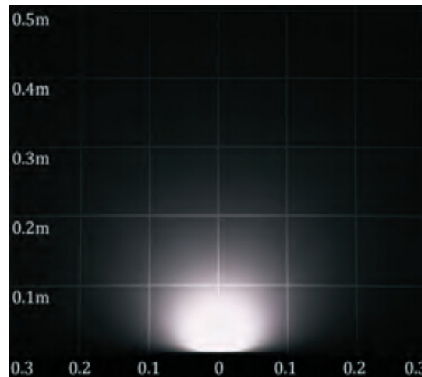

IASPL INGROUND DOT LARGE R MONO is a decorative point of light and suitable for integration in floors, ceilings, walls or stairs indoors and outdoors.

- dimmable or DMX 512, DALI, 1-10 V controllable by IASPL RGB MULTI power supplies/controller
- incl. PVC plastic mounting sleeve



Technical Data

| | |
|------------------------------|---|
| IP classification: | IP67 (for outdoor use) |
| Power source: | 24 VDC |
| Ring: | stainless steel 316 |
| Housing: | powder coated aluminium grey 8 mm tempered glass |
| Mounting sleeve: | PVC plastic |
| Load capacity: | exert force area of $\varnothing 10 \text{ mm} = 600 \text{ kg}$ $\varnothing 30 \text{ mm} = 1800 \text{ kg}$ |
| Electrical connection: | 1x cable 0,5 m H05RN-F 4x 0,75 mm ² to open wires |
| Operating temperature range: | -10° C till +45° C |

Photometric Data

| | | | |
|---------------------|------------------------------------|-------------|-------------|
| LED type: | OSRAM SMD LEDs ULTRA BRIGHT 3-in-1 | | |
| Luminous flux: | white | 15 | Lumen per m |
| | warm white | 15 | Lumen per m |
| Colour temperature: | white | 5500-6500 K | |
| | warm white | 2700-3500 K | |
| CRI: | white | 70+ | |
| | warm white | 70+ | |
| Beam angle: | 120° | | |

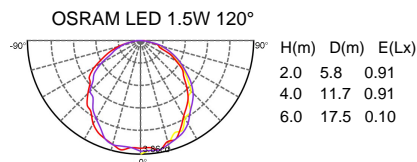

Product Type

IES is available

| order code | colour | LED pcs | LED power | Power consumption* | weight |
|------------|------------|---------|-----------|--------------------|--------|
| BZCYF60 | white | 6 | 1.5 Watt | 1-1.5 Watt | 0.9 kg |
| BZCYF30 | warm white | 6 | 1.5 Watt | 1-1.5 Watt | 0.9 kg |

Actual power consumption

INGROUND DOT LARGE S MONO

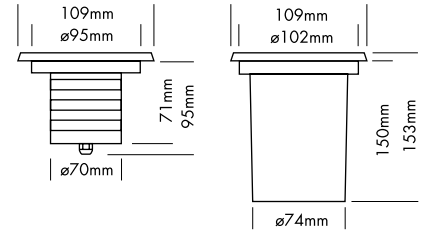
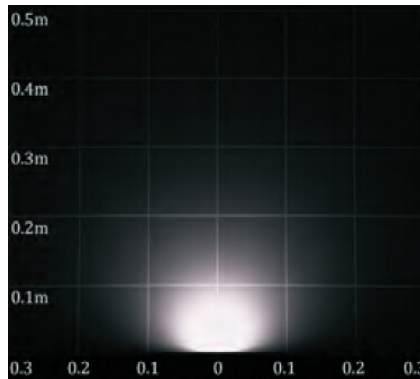

IASPL INGROUND DOT LARGE S MONO is a decorative point of light and suitable for integration in floors, ceilings, walls or stairs indoors and outdoors.

- dimmable or DMX 512, DALI, 1-10 V controllable by IASPL RGB MULTI power supplies/controller
- incl. PVC plastic mounting sleeve



Technical Data

| | |
|------------------------------|---|
| IP classification: | IP67 (for outdoor use) |
| Power source: | 24 VDC |
| Ring: | stainless steel 316 |
| Housing: | powder coated aluminium grey 8 mm tempered glass |
| Mounting sleeve: | PVC plastic |
| Load capacity: | exert force area of $\varnothing 10$ mm = 600 kg $\varnothing 30$ mm = 1800 kg |
| Electrical connection: | 1x cable 0,5 m H05RN-F 4x 0,75 mm ² to open wires |
| Operating temperature range: | -10° C till +45° C |

Photometric Data

| | | | |
|---------------------|------------------------------------|-------------|-------------|
| LED type: | OSRAM SMD LEDs ULTRA BRIGHT 3-in-1 | | |
| Luminous flux: | white | 15 | Lumen per m |
| | warm white | 15 | Lumen per m |
| Colour temperature: | white | 5500-6500 K | |
| | warm white | 2700-3500 K | |
| CRI: | white | 70+ | |
| | warm white | 70+ | |
| Beam angle: | 120° | | |

OSRAM LED 1.5W 120°

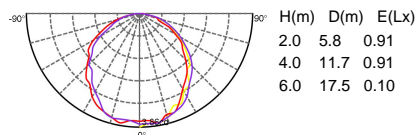

Product Type

IES is available

| order code | colour | LED pcs | LED power | Power consumption* | weight |
|------------|------------|---------|-----------|--------------------|--------|
| BZCXF60 | white | 6 | 1.5 Watt | 1-1.5 Watt | 0.9 kg |
| BZCXF30 | warm white | 6 | 1.5 Watt | 1-1.5 Watt | 0.9 kg |

Actual power consumption

INGROUND LINEAR TRILED RGB

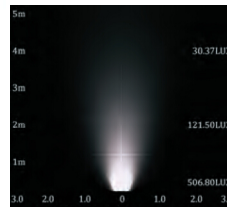
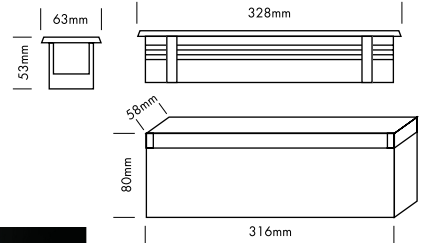

IASPL INGROUND LINEAR TRILED series is designed for floor or ceiling integration and offers various design possibilities in architectural illumination.

- dimmable, autom. colour change, DMX 512, DALI, 1-10 V controllable by IASPL RGB MULTI power supplies/controller
- incl. PVC plastic mounting sleeve



Technical Data

| | |
|------------------------------|---|
| IP classification: | IP67 (for outdoor use) |
| Power source: | 24 VDC Common Cathode (CC) |
| Ring: | stainless steel 316 |
| Housing: | powder coated aluminium grey 8 mm tempered glass |
| Mounting sleeve: | PVC plastic |
| Load capacity: | exert force area of $\varnothing 10$ mm = 500 kg $\varnothing 30$ mm = 900 kg, $\varnothing 60$ mm = 1200 kg |
| Electrical connection: | 1x cable 0,5 m H05RN-F 4x 0,75 mm ² to open wires |
| Operating temperature range: | -10° C till +45° C |

Photometric Data

| | | |
|----------------|--------------------------------|-----------|
| LED type: | OSRAM RGB 3-in-1 LEDs 1,5 Watt | |
| Luminous flux: | red | 30 Lumen |
| | green | 75 Lumen |
| | blue | 15 Lumen |
| | r+g+b (white) | 120 Lumen |
| Wave length: | red | 625 nm |
| | green | 518 nm |
| | blue | 462 nm |
| Beam angle: | 30° | |

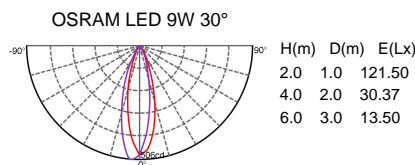

Product Type

IES is available

| order code | colour | LED pcs | LED power | Power consumption* | weight |
|------------|--------|---------|-----------|--------------------|---------|
| BZB32R | RGB | 6 | 9 Watt | 8-18 Watt | 8-10 kg |

Actual power consumption

INGROUND LINEAR MONO

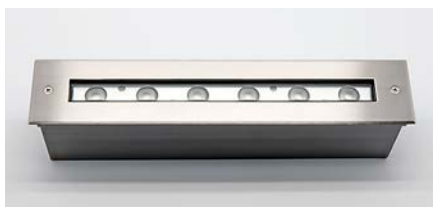
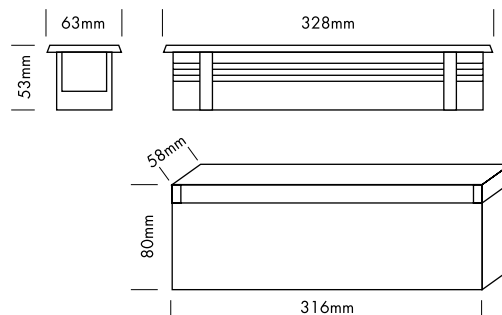

IASPL INGROUND LINEAR MONO series is designed for floor or ceiling integration and offers various design possibilities in architectural illumination.

- dimmable or DMX 512, DALI, 1-10 V controllable by IASPL RGB MULTI power supplies/controller
- incl. PVC plastic mounting sleeve

Technical Data

| | |
|------------------------------|---|
| IP classification: | IP67 (for outdoor use) |
| Power source: | 24 VDC |
| Ring: | stainless steel 316 |
| Housing: | powder coated aluminium grey 8 mm tempered glass |
| Mounting sleeve: | PVC plastic |
| Load capacity: | exert force area of $\varnothing 10$ mm = 500 kg $\varnothing 30$ mm = 900 kg, $\varnothing 60$ mm = 1200 kg |
| Electrical connection: | 1x cable 0,5 m H05RN-F 2x 1,0 mm ² to open wires |
| Operating temperature range: | -10° C till +45° C |

Photometric Data

| | | |
|---------------------|-------------------------|-------------|
| LED type: | OSRAM 1 Watt high power | |
| Luminous flux: | white | 650 Lumen |
| | warm white | 480 Lumen |
| Colour temperature: | white | 5500-6500 K |
| | warm white | 2700-3500 K |
| CRI: | white | 70+ |
| | warm white | 80+ |
| Beam angle: | 30° | |

OSRAM LED 6W 30°

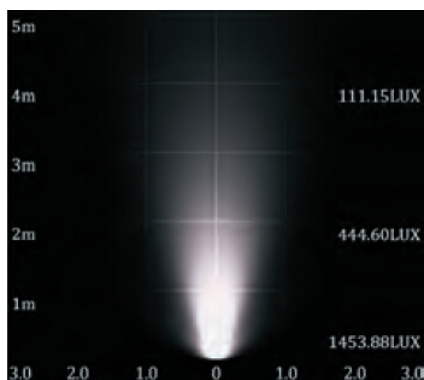
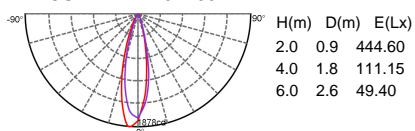

Product Type

IES is available

| order code | colour | LED pcs | LED power | Power consumption* | weight |
|------------|------------|---------|-----------|--------------------|--------|
| BZB3260 | white | 6 | 6 Watt | 7-8 Watt | 1.2 kg |
| BZB3230 | warm white | 6 | 6 Watt | 7-8 Watt | 1.2 kg |

Actual power consumption